

# Shielding

INNER LINING



A shielded room which is built according to the principle of the Faraday cage protects against radiated electromagnetic interference. Walls, floor and ceiling must be made of metal which has the physical property to mainly reflect and partially absorb electromagnetic energy in the frequency range from 9 kHz to 400 Ghz.

## Purpose & Overview

WHAT IS THIS SOLUTION FOR? .....

Our shielding is designed to cover electromagnetic radiation in the frequency ranges up to 40 GHz. Our shielding provides bandwidth suitable for the following applications:

- EMC and microwave test sites
- MRI rooms
- EMP and Tempest protection
- RF shielding for industry

Two millimeter thick, hot galvanized sheet steel has proven best suited for high performance shielding. Depending upon requirements, the shielding surface can be built either in modular prefabricated panels (pan type bolted shielding) or in the classical welded steel sheet panels (pan type welded shielding). We utilize other materials and techniques when requested for special purposes such as architectural, copper, and textile shielding.

The fully integrated system consists of several shielding components such as panels, doors, honeycombs, windows, access panels, electrical filters and a large range of shielding penetration elements for all kinds of media interface. Many of these components require a ductile, stable, and long lasting RF-tight joint to the shielding itself. For this purpose we have developed a RF mesh capable of performing from several kHz to 40 GHz.

Individual components were developed with the focus of achieving superb electromagnetic shielding performance with the understanding that the limit of effectiveness would be set by the weakest component. The concept of modularity was created in the later part of the twentieth century but has since evolved to suit global requirements.



# Quality Management

## QUALITY MEANS DOING IT RIGHT FROM THE VERY FIRST THOUGHT. ....

Our quality management ensures a most efficient quality control over products, management and organizational systems.

The organization ensures the availability of resources and information necessary to support the operation and monitoring of these processes. All relevant processes are defined in our management system. Through monitoring, analysis, and improvement, the highest quality and customer satisfaction is our target.

In an effort to improve our quality assurance systems, we ask our customers to provide an evaluation of our performance at the conclusion of each project. This feedback, coupled with input from the market and the Standards Committees, gives continuous enhancement to our systems and correction to any non-conformity found.

Product purchasing and sourcing is a priority in our role as system integrator, so much that it encompasses one of sixteen chapters in our quality and environmental management system. Key process figures are:

- audit & approval of suppliers
- evaluation of products by our technical team
- technical reporting on delivered products
- project related factory acceptance by the project manager.

In our commitment to quality solution designs, we work closely with our longtime suppliers to ensure that our stringently designed specifications are met.

Quality is not only doing it right from the very beginning, but also delivering the right products in the expected quantity on the scheduled dated at the right place. For a global solutions supplier, these aspects are key. Each project is subject to a quarterly review of quality, cost, and delivery specifications.

Our ISO 9001 and ISO 14001 certification guarantees that our designs, products, and solutions will always meet the highest quality standards. It's our goal to provide you the very best of expertise, project management, and products. The main system components like shielding, absorbers etc. are manufactured by daughter companies or by our shareholders. This ensures a full control with regard to quality and delivery time.

# SHIELDING

An industrial RF shielded room is composed of conductive or magnetic elements which can be connected RF-tight in different ways.

## Pan type bolted

FLEXIBILITY IS THE TARGET. ....

Superior shielding performance is the expected result when the manufacturing process mandates consistent, quality production of panels with precision shape and size, made possible through CAD/CAM processing. The features of pan type bolted shielding are:

- Modules produced from 2 mm (0.08 in) thick, hot galvanized sheet steel bent up to form a pan tray
- Corrosive protection Zinc layer of minimum 275 g/m<sup>2</sup> (0.91 oz/ft<sup>2</sup>)
- Standard module heights of 2.55 m (8 ft) and 3.00 m (10 ft); custom heights are also available
- RF flange depth is 50 mm (1.97 in) with fixing holes at 75 mm (2.95 in) spacing. RF-seal between the modules by means of a contact mesh. Tightened with M10 fixings and compressed to a 100% homogeneous seal.

## Pan type welded

CONFORM TO BUILDING SHAPE. ....

Shielded rooms can be built in Modular Welded Shielding Technology (MWST). The basic material is 2 mm (0.08 in) galvanized steel. The MWST panels are pre manufactured with a size of 1.2 m x 3.1 m (4 ft x 10 ft). MWST is best suited for applications in rough environmental and climatic conditions as well as applications with aggressive chemicals.

MWST panels are tungsten inert gas (TIG) welded on site by a double flanged seam with 40 mm (1.6 in) height. The welding is supported by TIG welding robots. The dimensions of the pre manufactured panels are a multiple of the absorber unit size which can be glued directly to the panels.

## Steel structure

MAINTAINING THE STRUCTURE. ....

The steel structure supports the shielding of large chambers making them free standing and independent from the host building. The steel structure carries all the distributed loads from the chamber's ceiling and walls and is designed to take the additional point loads resulting from such items as an EH-Generator or ceiling antenna rail systems.

Consequently the support structure weight is a huge factor in the calculation and planning of the facility. A typical support structure is shown below.

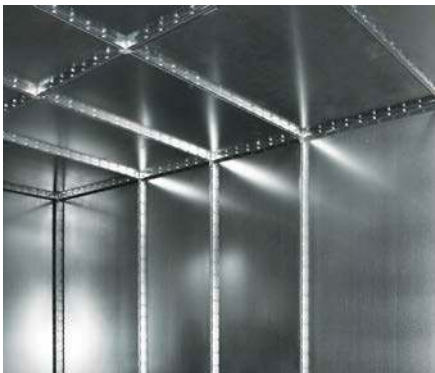

# DOORS

The proven full metal design of our shielded doors consists of a metal frame, contact springs and metal door leaf forming a modular door panel.

Using our unique RF sealing method, the door panel is RF-tight to the other shielding panels. Due to its superior shielding effectiveness, the blade contact system is the preferred contact mechanism for doors. Z-spring or divided spring contacts are available upon request for special site specific requirements. Opening and closing the door has a self-cleaning effect on the contact surfaces.

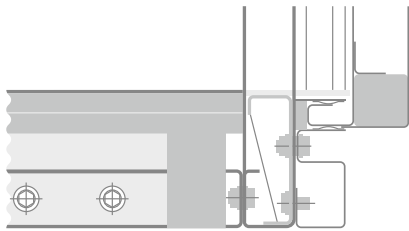

Blade contact door: Vertical cut through floor and threshold

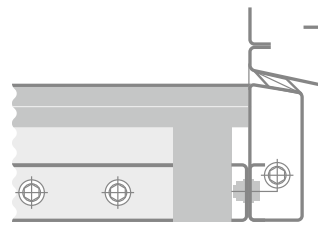

Z-spring door: Vertical cut through floor and threshold

## Swing doors

QUICK AND EASY TO MOVE. ....

Swing doors are available in two styles, single or double wing, neither of which compromise shielding effectiveness. Easily operated and cost effective, swing doors have the advantage of mounting the absorbers directly to the door leaf. Standard sizes are (W x H):

### Single wing

- 0.900 m x 2.050 m/2.500 m (3 ft x 7 ft/8 ft)
- 1.200 m x 2.050 m/2.500 m (4 ft x 7 ft/8 ft)
- 1.500 m x 2.050 m/2.500 m (5 ft x 7 ft/8 ft)
- 2.100 m x 2.050 m/2.500 m (6 ft x 7 ft/8 ft)

### Double wing

- 1.500 m x 2.050 m/2.500 m (5 ft x 7 ft/8 ft)
- 1.800 m x 2.050 m/2.500 m (6 ft x 7 ft/8 ft)
- 2.100 m x 2.050 m/2.500 m (6 ft x 7 ft/8 ft)
- 2.400 m x 2.050 m/2.500 m (8 ft x 7 ft/8 ft)
- 2.700 m x 2.050 m/2.500 m (9 ft x 7 ft/8 ft)

## Sliding doors

OPTIMIZED SPACE SAVING. ....

Sliding doors are suitable whenever moving space is limited. This technology offers the same shielding attenuation levels as the swing doors.

Standard sizes are (W x H):

### Sliding door

- 1.200 m x 2.050 m (4 ft x 7 ft)
- 1.500 m x 2.050 m (5 ft x 7 ft)
- 2.100 m x 2.050 m (6 ft x 7 ft)

# DOOR ACTUATION AND ACCESSORIES

The actuation and accessories provide those additional features that suit customized requirements while keeping safety and comfort in place.

## Door actuation

### SAFE AND EASY HANDLING. ....

Door actuation is extremely important and should be safe and easy for the user. Proper handling can contribute to the life of the door contact system. For our doors we offer:

- Mechanical actuation by means of an easy moving lever (maximum force required 70 N (15.8 lbf)), available with lock
- Pneumatic and electric actuation by the simple push of a button

Both power options offer the following features:

- Integration to a centrally controlled door monitor
- Automatic close in case of fire
- Adaptation to access card reader systems

The electric actuation is limited to a door width of 1.2 m (4 ft). For interlock rooms, also known as RF vestibules, the doors are interlocked together such that only one door can be opened at a time thus ensuring there is permanent shielding of the protected area. Under emergency conditions, there are a number of safety controls built into the door interlock system which allow both doors to open simultaneously. For interlock rooms, pneumatic or electric doors are suitable.

## Door accessories

### INTERLOCK SWITCH. ....

As an option, micro switches can be incorporated into doors for connection to a security system. They can also be used as a safety interlock of RF amplifiers during EMS testing (i.e. when opening the RF door to gain access to the chamber, the amplifiers are automatically switched off). This is a mandatory safety requirement as high RF fields are hazardous to humans.

### RAMP SYSTEMS FOR SHIELDED DOORS. ....

Due to the particular geometry of the door RF contact surfaces, our shielded doors feature a threshold height of 130 mm (5.12 in). While this is appropriate for personnel access, light EUT's and other equipment, heavier products require a ramp system. Three solutions are available:

- Manual ramp for blade contact doors/MB-BCD
- Semi-automatic ramp for blade contact doors/SAB-BCD
- Lifting platform to allow for entrances with high thresholds





# GATES

Sliding gates have become the most suitable solution for absorber lined shielded areas providing obstacle-free entrance and easy access for large EUT.

## Sliding gates

EASY MAINTENANCE FOR EVERLASTING FUNCTION AND PERFORMANCE. ....

Our sliding gates are made of proven full metal construction. They consist of a metal frame hosting the RF contact system and the metal door leaf with the contact springs mating to the metal frame. The contact mechanism is a blade contact system, special solutions like divided spring contacts are available for specific purposes. Opening and closing the gate has a self-cleaning effect. Maintenance of the gate sealing contacts is easily carried out with the use of a screwdriver or small spanner. Gates are available in manual, semi-automatic, and fully automatic versions. On the gate leaf, every type of absorber can be fixed up to a length of 2.5 m (8 ft).

The available standard sizes are (W x H):

- 2.4 m x 2.4 m (8 ft x 8 ft)
- 3.0 m x 3.0 m (10 ft x 10 ft)
- 3.0 m x 3.6 m (10 ft x 12 ft)
- 4.2 m x 4.2 m (14 ft x 14 ft)



## Master drive technology (MDT)

FEWER PARTS AND COMPONENTS INCREASE THE MTBF OF A SYSTEM. ....

Due to the simple and failsafe mechanics, the MDT is an advanced design for extended life and low maintenance. Reliability has increased considerably with a 25% reduction of individual components forming the drive system. The technology is applicable for sliding gates lined with absorbers of any size. The gate control is interlinked with the traversing bridge and both can be operated automatically.

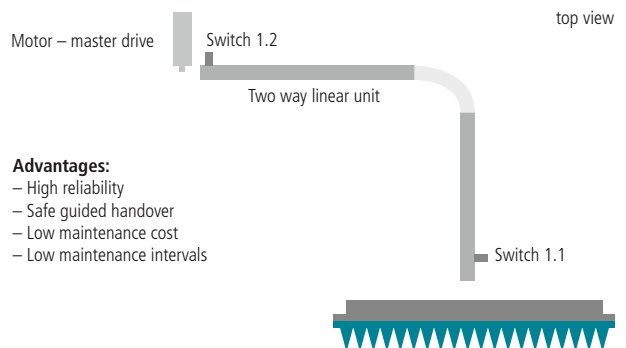

# GATE ACCESSORIES

Accessories provide additional custom features to enhance gate performance, safety, and comfort.

## Gate control panel

MONITORING THE GATE'S FUNCTION HISTORY. ....

The gate control panel houses buttons for opening, closing and emergency release. All conditions are monitored and displayed through an LCD touch panel, including the service interface for maintenance. SIMATIC software, used to coordinate all operations, can monitor and update by remote link. The panel is designed with "integrated intelligence" providing figures for service interval:

- environmental air pressure monitoring
- chamber's internal pressure level



## Gate bridge

SAFE AND EASY ACCESS FOR ANY KIND OF EUT. ....

The gate is equipped with an automatic bridge which is interlinked with the gate move to avoid collisions. Two bridge designs are available:

- Ramp type
- Lift type

### Bridge Technology Comparison

Ramp type:

- + little space requirement
- height difference

Lift type:

- + no height difference
- large space requirement

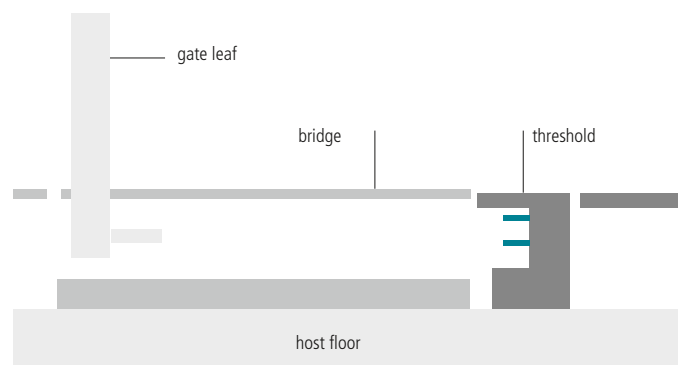
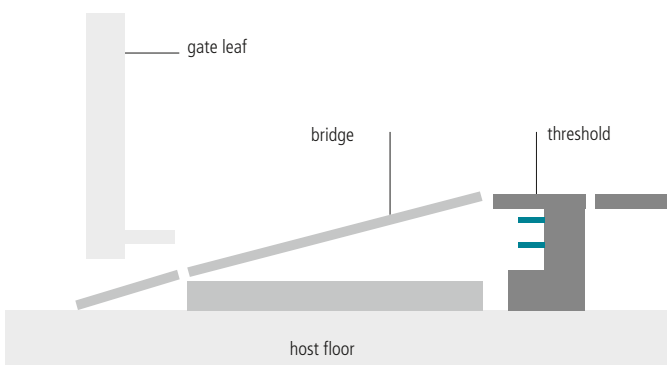

# SHIELDING COMPONENTS

Making a Faraday cage become a fully functional facility.

## Honeycombs

KEEP THE RF OUT LETTING AIR AND LIQUIDS IN. ....

This shielding element is primarily used for a ventilation inlet as gaseous media can pass the honeycomb structure at a high flow rate. Gases from combustion engine vehicles can be exhausted using high temperature inserts.

Honeycomb inserts consist of a matrix of metal waveguides. Their shielding effectiveness is based on the attenuation behavior of waveguides beyond cut-off frequency also depending on the length and number of waveguides. Our standard honeycomb range is 1 GHz, 20 GHz and 40 GHz. Our honeycomb modules are supplied with edge profiles bolted with contact mesh to the shielding modules. Flanges are provided for connection to the air conditioning system or fan ventilation as appropriate.

Standard honeycomb sizes are:

330 mm x 330 mm (12 in x 12 in)

500 mm x 500 mm (20 in x 20 in)

130 mm x 1,000 mm (5.12 in x 39.4 in)

However, other sizes can be manufactured according to customer's requirements.

## Windows

WHEN DAYLIGHT IS REQUIRED AND RF SHIELDING IS NEEDED. ....

Government regulations, safety concerns and working requirements are only a few of the reasons to implement windows into an electromagnetic shielding solution. Accordingly, shielded windows are designed for various purposes in the industrial, medical, and governmental markets (e.g. view purposes, EUT monitoring, safety concerns).

Shielding applied to glass can be created through metal vaporization and/or metal gasket screening. Since the shielding is a function of the layer quantity, the ratio of visibility versus shielding attenuation is determined by the application. Reasonable visibility is expected at shielding attenuation values of approximately 40 dB up to 90 dB at 1 GHz. The range of customized solutions includes fixed versions and others which can be opened.



# MEDIA INTERFACES

Media such as gas, liquid, signals, or data lines must be brought to the Faraday cage and made available for use without damage to the shielding effectiveness.

## Penetration pipes

FOR EXCEPTIONAL USE. ....

Penetration pipes are used in many ways such as feeding various types of media, (e.g. liquids, gases, compressed air, fiber optics) to the cage. When pipe diameter exceeds the waveguide cut-off, we use honeycomb inserts inside to allow superb liquid and gaseous media flow rate. For temporary and experimental EUT cabling, we offer a solution with shielding effectiveness of 60 dB to 1 GHz. For fiber optic cable, our solution has the following advantages:

- Quick and easy cable laying
- No adapted connector required
- Up to 6 fiber optic cable

## Feed-through panels

FLEXIBLE AND RF-TIGHT. ....

To mount the various feed-through elements the facility will include penetration panels. These panels are available with different feed-through devices according to customer requirements and can be supplied as 'bolt-on' or 'plug-in' versions. These mounting methods allow great flexibility of the shielding structure. Feed-through devices such as RF connectors and data line filters can be easily exchanged.

Standard feed through panel sizes are:  
400 mm x 400 mm (15.8 in x 15.8 in)  
625 mm x 625 mm (24.6 in x 24.6 in)  
100 mm x 1,000 mm (3.9 in x 39.4 in)  
1,000 mm x 1,000 mm (39.4 in x 39.4 in)

However, other sizes can be manufactured according to customer's requirements.

## Connection points

KEEPING YOUR FLOOR CLEAN. ....

To avoid absorber chamber imperfection, all interface outlets inside the chamber are located at the floor side. To mount the various feed-through elements, the facility has floor integrated connection points. These connection points (CP) can be equipped with different feed-through devices and sockets to meet customer requirements. The design of the connection points, with its frame and detachable bottom, make future add-ons easy.

Standard floor connection point sizes are:  
450 mm x 450 mm (17.7 in x 17.7 in)  
700 mm x 700 mm (27.6 in x 27.6 in)

However, other sizes can be manufactured according to customer's requirements.



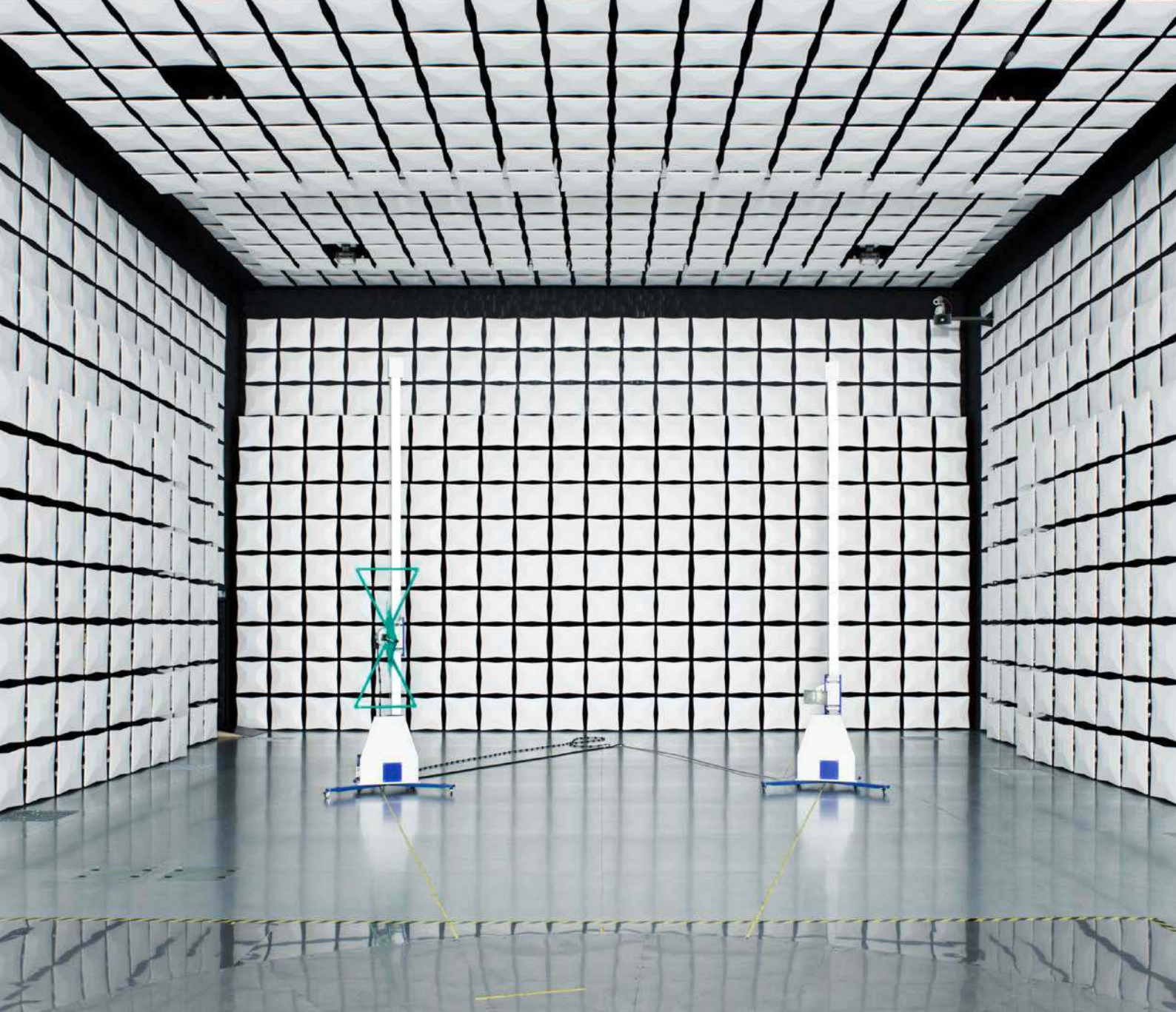

# INNER LINING

If required, the walls and the ceiling of the shielded area can be provided with an interior lining; this offers not only an attractive working environment but also sound absorption up to typically 50 dBa.

## Plywood panels

SLOTS ABSORB THE SOUND. ....

Plywood panels not only offer superb sound absorption, but are an attractive option suitable for offices, studios, computer rooms, and switching stations. Slotted tubular chipboards cover real-wood veneer (flame-retardant as per DIN 4102, class of incendiary material B1 or B2). The chipboards are either permanently fixed to a wooden framework or are suspended from steel sub-structure which retains the full modularity of the facility's construction. Upon request, the ceiling interior lining can be integrated into the ventilation concept of the room.

## Gypsum-/Plasterboard

FINISHES FAVORABLY PRICED. ....

We offer a wide selection of interior linings. The variety of finishes includes a colorful array of painted gypsum walls, wood paneling, plasterboard with glass fiber tapestry and painting, and melamine coated chipboard in a large choice of colors. The suspended ceiling system in the RF room can be individually adapted to the particular design requirements. Acoustic absorption can be enhanced by adding glass wool materials behind the interior lining. Flame retardant versions of our linings are available upon customer request.

## Frameless design

HIGH-END DESIGN AND FUNCTION. ....

We offer a high-end interior finishing for conference rooms and C<sup>3</sup> Centers, with sound proof and fire retardant properties. LED technology is already used in many applications, including the inside of a RF room. This calls for a large number of lighting solutions, from basic LED warm or cold lighting, to ultra high-end designs using LED light bars. Such systems are controlled from outside the RF room and can provide the most comfortable and ergonomic working environment inside the RF room. Other significant advantages of LED lighting are their inherent long life, low power consumption, and low heat generation.





Contact addresses

**Albatross Projects GmbH**

Daimlerstrasse 17  
89564 Nattheim  
Germany

Phone +49 7321 730-500  
Fax +49 7321 730-590  
E-mail [info@albatross-projects.com](mailto:info@albatross-projects.com)

**AP Americas Inc.**

1500 Lakeside Parkway, Suite 100-B  
Flower Mound, TX 75028  
USA

Phone +1 972 295 9100  
Fax +1 972 810 3223  
E-mail [info@apamericas.com](mailto:info@apamericas.com)

**Albatross Projects RF Technology  
(Shanghai) Co., Ltd.**

No. 2998 Longwu Road, Xuhui District,  
Shanghai 200231  
P. R. China

Phone +86 21 6434 1110  
Fax +86 21 6434 7800  
E-mail [info@albatross-projects.com.cn](mailto:info@albatross-projects.com.cn)

**Albatross Projects RF Technology  
India Private Limited**

312, Siddhraj Zori,  
Near Sargasan Cross, KH-0,  
Off S.G. Highway  
382421 Gandhinagar, Gujarat  
India

Phone +91 97 3737 9537  
Fax +91 79 2975 0780  
E-mail [info@albatross-projects.in](mailto:info@albatross-projects.in)